

UATYARPH5
UATYARPH6

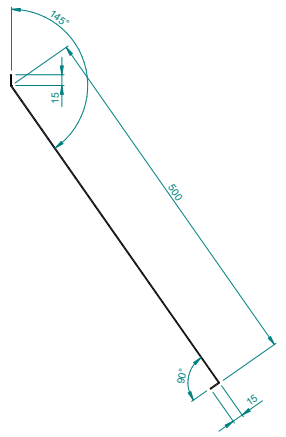

Section A-A

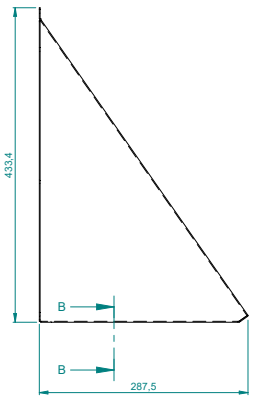
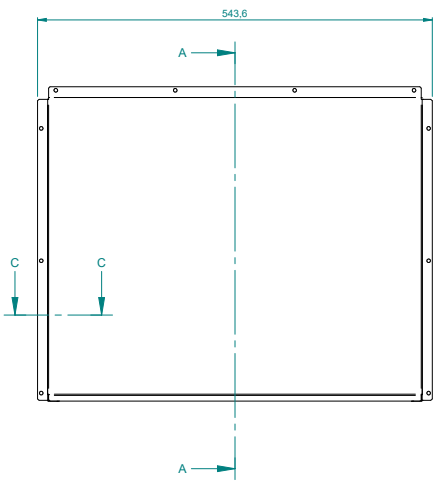
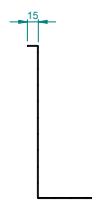

Section C-C

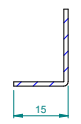

Section B-B

