

EWAD900-950BJYNN/Q

EWAD850BJYNN/Z

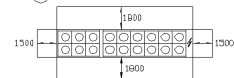
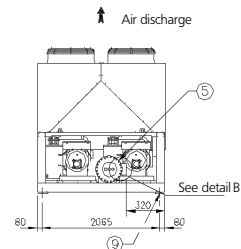
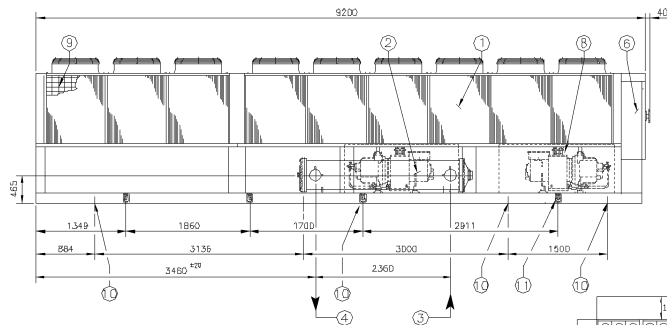
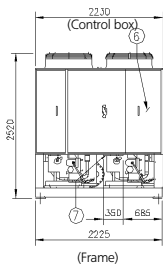

Fan arrangements and minimum clearance requirements

Legend

- ① Condenser coil
- ② Evaporator
- ③ Evaporator water inlet
- ④ Evaporator water outlet
- ⑤ Victaulic connections for 219.1 O.D. tube
- ⑥ Operating and control panel
- ⑦ 360x150 slot for power and control panel connection
- ⑧ Compressor enclosure
- ⑨ Coil protection guards (optional)
- ⑩ 8 isolator mounting holes 25 mm DIA.
- ⑪ 8 lifting shackles

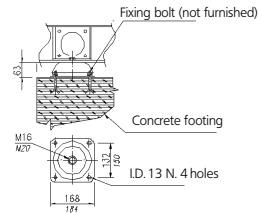
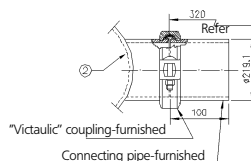
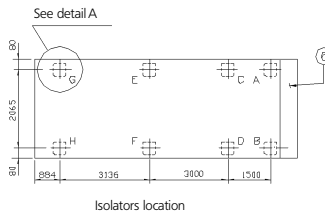

Condenser type	Weight KG		Isolators load KG							
	Shipping	Operating	A	B	C	D	E	F	G	H
Aluminium	8725	9150	1270	1270	1090	1090	1545	1545	670	670
Acrylic coated										
Rubber isolators	Type (q/ty)		786010-m (4 Pz)				786010-h		786011-h (2 Pz)	

786011-h
786010-h / 786010-m

Detail B

Detail "A" rubber isolator