

Required space for service and ventilation

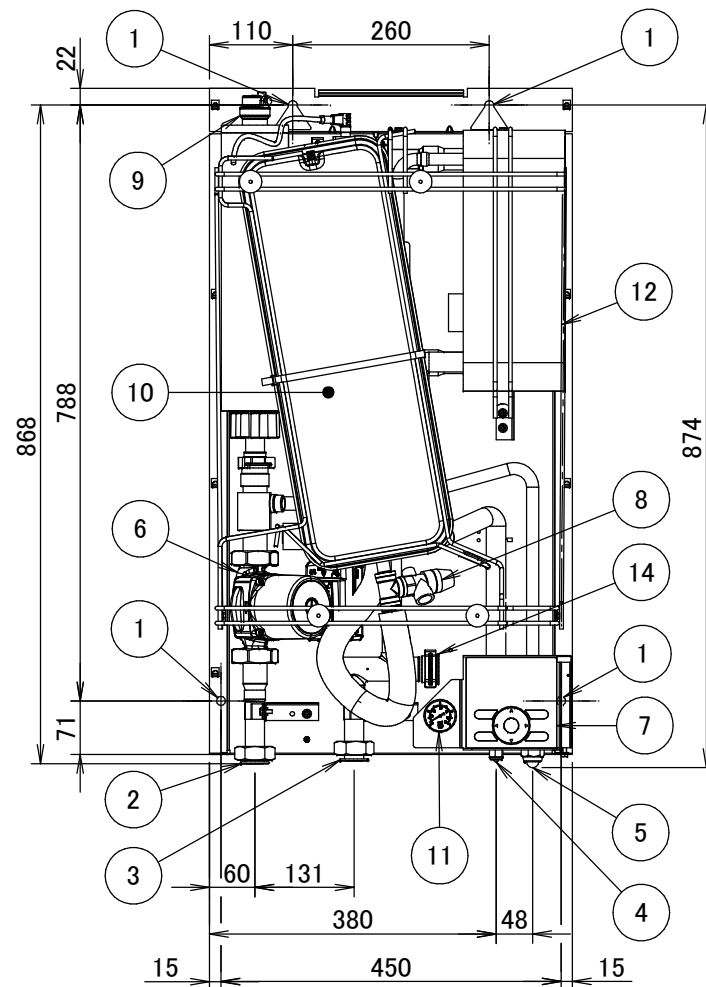

- 1 Holes (Ø12) for wall fixation
- 2 Water out connection (1-1/4" F BSP)
- 3 Water in connection (1-1/4" F BSP)
- 4 Refrigerant liquid connection Ø9.52
Flare connection
- 5 Refrigerant suction connection Ø15.9
Flare connection
- 6 Pump
- 7 User interface
- 8 Safety valve
Pressure
- 9 Air purge
- 10 Expansion vessel
- 11 Pressure gauge
- 12 Heat exchanger (refrigerant / water)
- 13 Shut-off valve with drain / fill valve (1-1/4" F BSP) (included accessory)
- 14 Water filter
- 15 Wire entrance of the power supply / communication wire
- 16 Service door
- 17 Switch box terminals
- 18 Switch box terminals for the domestic hot water tank (option)

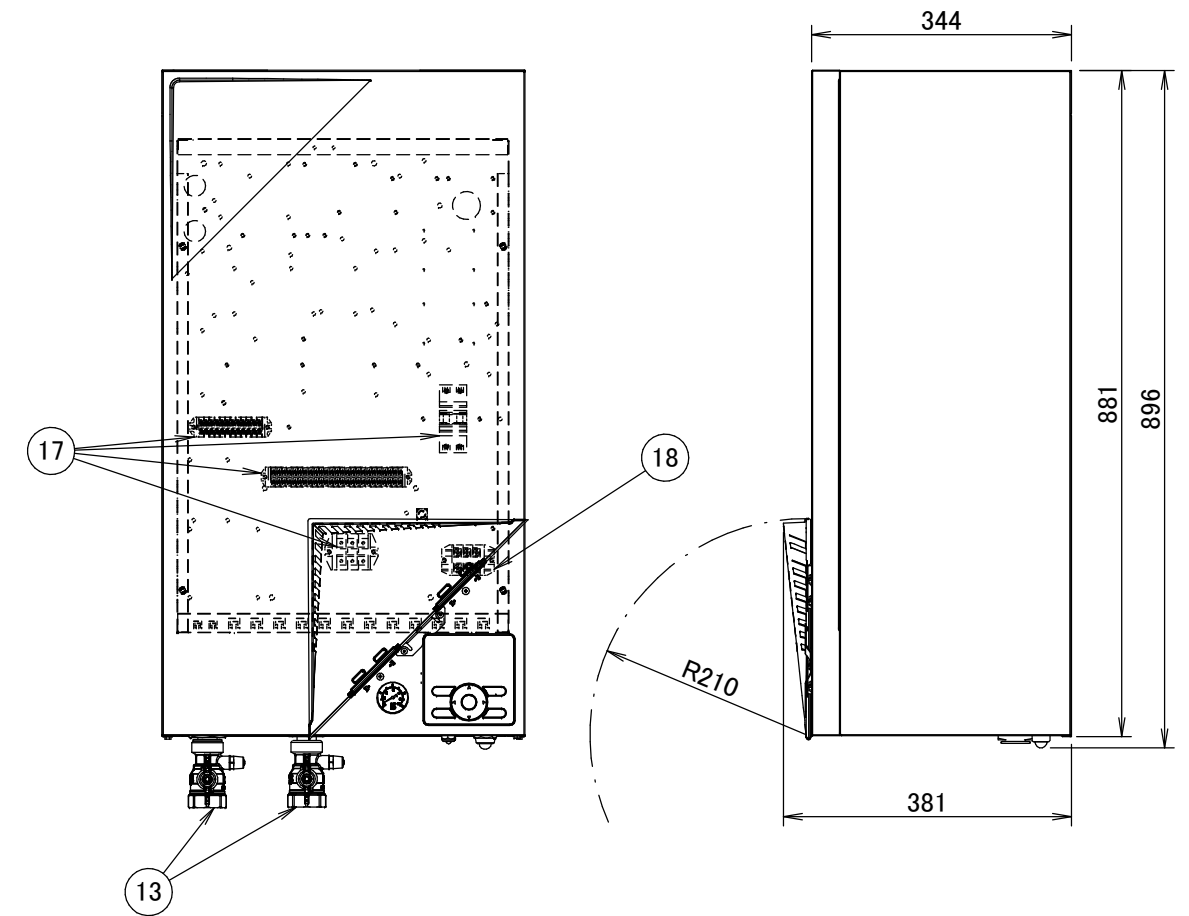
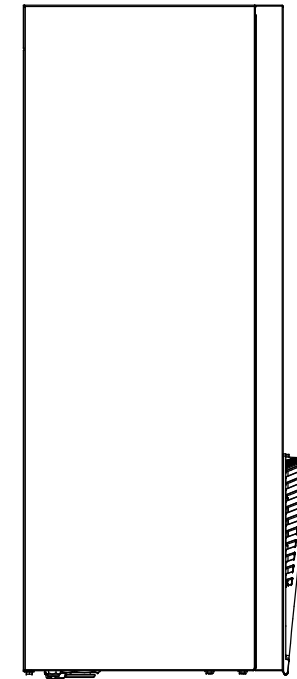
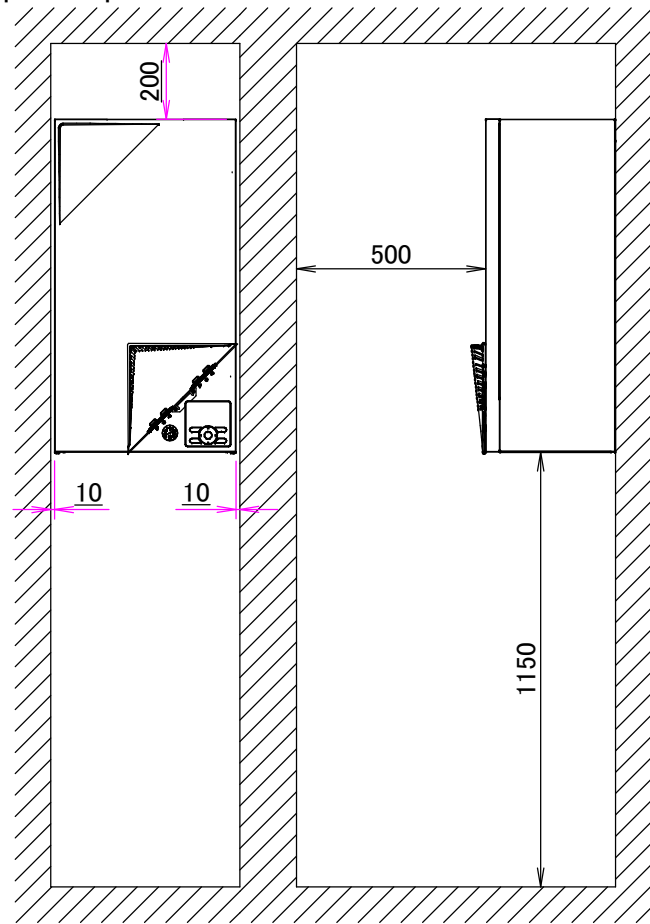