

EKHTS260AB+EKHBRD-AB

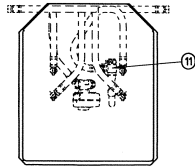

1. 3 way valve
2. Hot water out connection G 3/4" (Female)
3. Cold water in connection G 3/4" (Female)
4. Hot water out (quick coupling) at bottom tank
5. Cold water in (quick coupling) at bottom tank
6. Tank connection from *KHBRD (quick coupling)
7. Tank connection to *KHBRD (quick coupling)
8. Tank connection from *KHBRD (quick coupling) at bottom tank
9. Tank connection to *KHBRD (quick coupling) at bottom tank
10. Recirculation connection G 1/2" (Male)
11. T-joint
12. Knock-out holes for water piping
13. Levelling feet (on EKHBRD* unit)

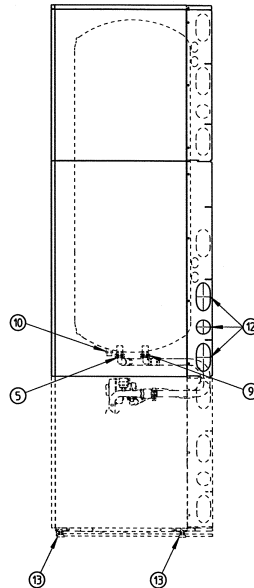
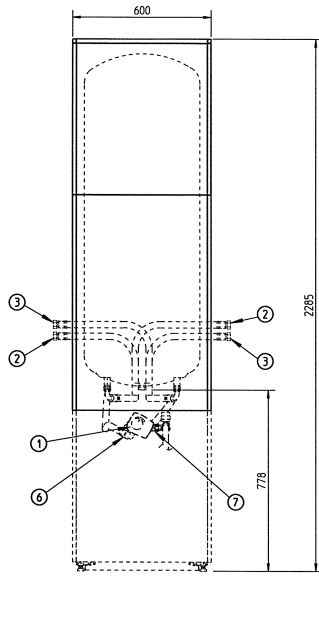
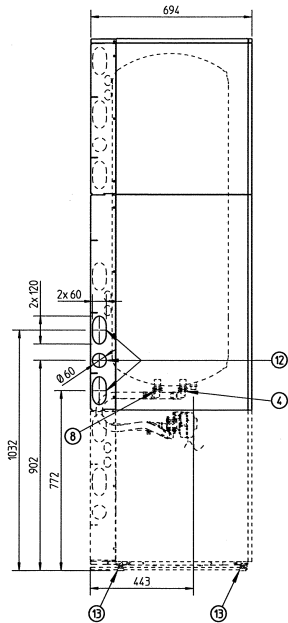

Note: For details on EKHBRD*AB refer to 3TW59854-1.