

EKHTSU260AB+EKHBRD-AB

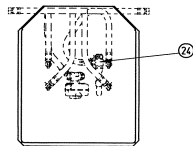

EKHTSU*

1. 3 way valve
2. Hot water out connection G 3/4" (Female)
3. Cold water in connection G 3/4" (Female)
4. Hot water out (quick coupling) at bottom tank
5. Cold water in (quick coupling) at bottom tank
6. Tank connection from EKHBRD (quick coupling)
7. Tank connection to EKHBRD (quick coupling)
8. Tank connection from EKHBRD (quick coupling) at bottom tank
9. Tank connection to EKHBRD (quick coupling) at bottom tank
10. Recirculation connection G 1/2" (Male)
11. Pressure and temperature relief valve 15mm (Male)
12. Knock-out holes for water piping
13. Levelling feet (on EKHBRD* unit)

EKUHWHTA-KIT

14. Cold water in connection 22mm
15. Pressure reducing valve 22mm - 22mm
16. Expansion relief valve 15mm - 15mm
17. Tundish 22mm - 15mm
18. T-piece (to expansion vessel) 22mm - 22mm - 22mm
19. Expansion vessel G 3/4" (Male)
20. Drain valve 22mm - G 3/4" (Female)
21. Reducing coupler 22mm - 15mm
22. Adapter (expansion vessel) 22mm - G 3/4" (Female)
23. Blind stop + 2 plastic screw-on closing caps for pressure reducing valve
24. T-joint

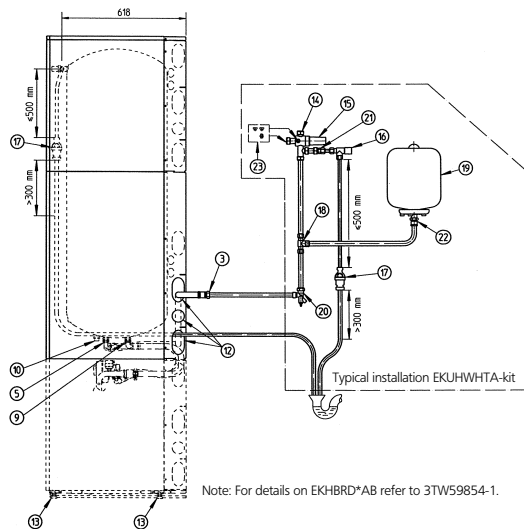
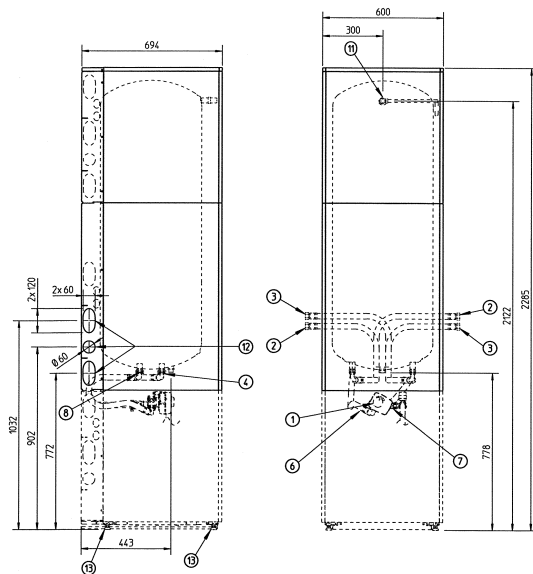

Note: For details on EKHBRD*AB refer to 3TW59854-1.