

Uscita del drenaggio
(flessibile di collegamento con diam. int.
 ϕ 15,9)

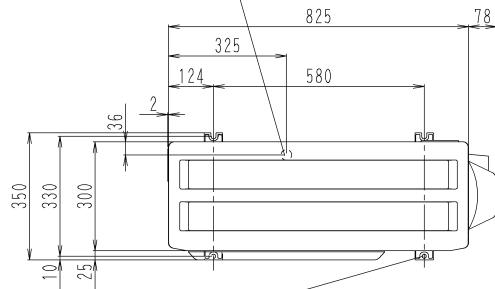

4 fori per viti d'ancoraggio (M8 o M10)

Targhetta di identificazione

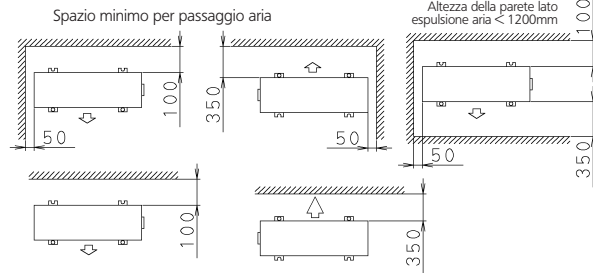
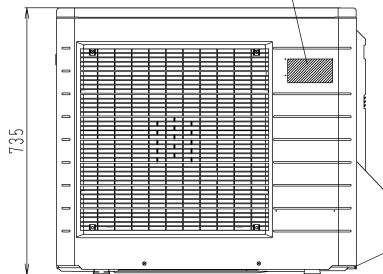
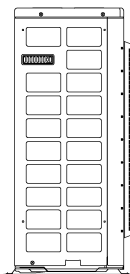

In caso di rimozione del coperchio delle
valvole di intercettazione

Etichetta
identificativa

Entrata dei cavi

Morsettiera con
collegamento di
terra

Termistore temperatura aria
esterna

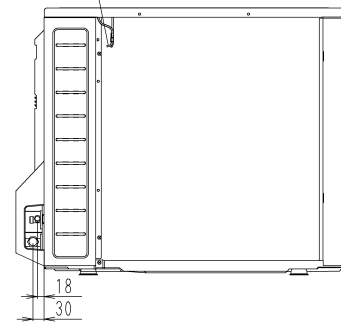
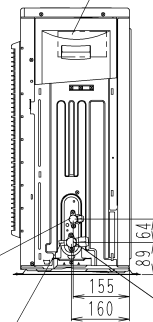
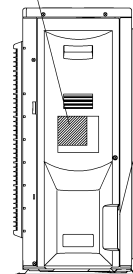

Valvola d'intercettazione
sulla linea del liquido
(ϕ 6.4 CuT)

Attacco di
servizio

Valvola di intercettazione
del gas
(ϕ 15.9 CuT)