

UATYA140-190BFC3Y1

"C" Right view

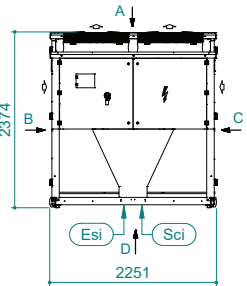

"B" Left view

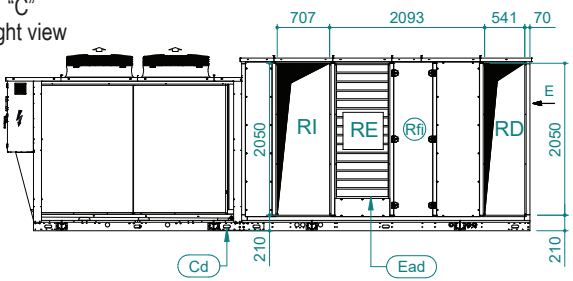
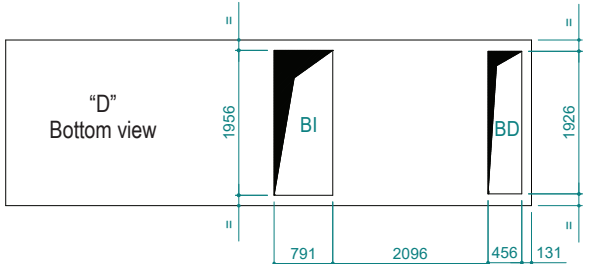
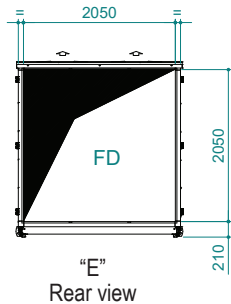
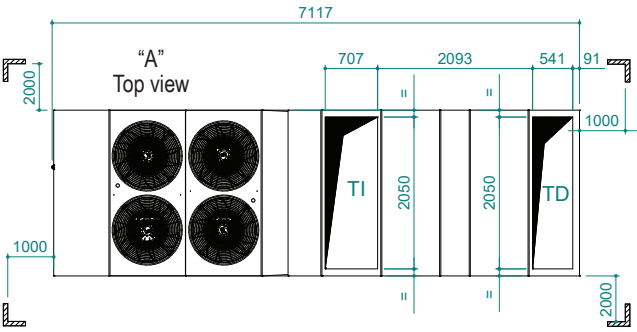
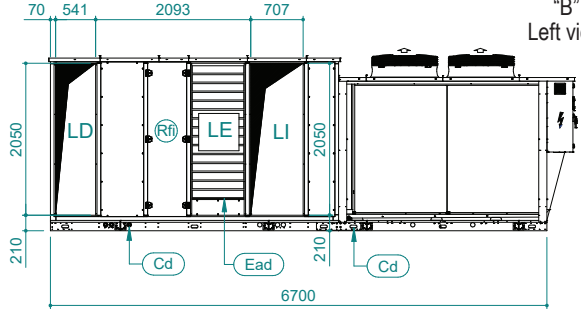

| Air direction | | | |
|---------------|-----------|--------|----------|
| Air direction | Discharge | Intake | External |
| Left | LD | LI | LE |
| Right | RD | RI | RE |
| Top | TD | TI | / |
| Bottom | BD | BI | / |
| Front | FD | / | / |

Sci Signal cables inlet

Ead External air damper

Esi Electrical supply inlet

Cd Condensate drain 1" male

Rfi Remove for inspection

Clearances

UATYA140-190BFC3Y1

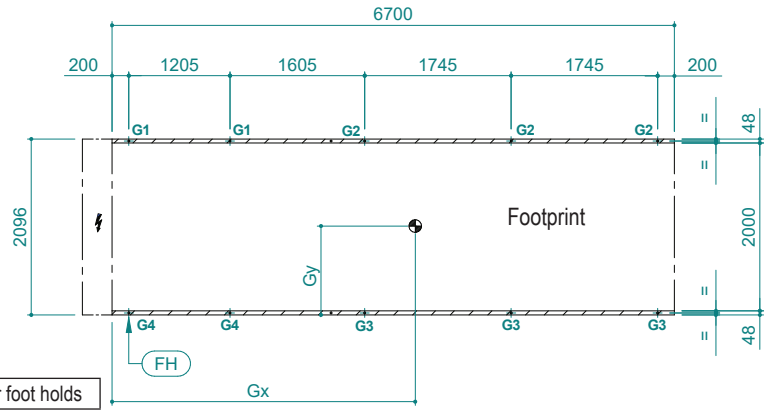
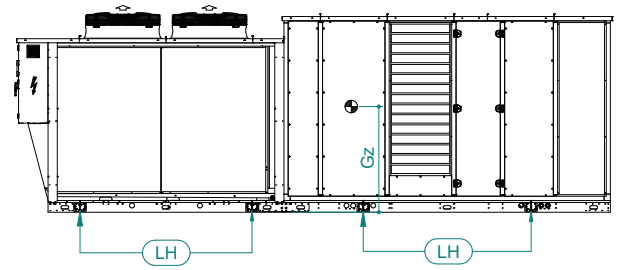

| | | | | |
|----|--------------|-----|----|---------------|
| Fh | Fixing holes | Ø22 | LH | Lifting point |
|----|--------------|-----|----|---------------|

| | |
|-----|-----------------------------|
| G.. | Vibration damper foot holds |
|-----|-----------------------------|

| Model | Weight (kg) | | | | | | | (mm) | | |
|----------------|-------------|-----------|-----|-----|-----|-----|------|------|------|--|
| | Shipping | Operating | G1 | G2 | G3 | G4 | Gx | Gy | Gz | |
| UATYA140BFC3Y1 | 3068 | 3024 | 390 | 305 | 239 | 306 | 3200 | 1188 | 1101 | |
| UATYA150BFC3Y1 | 3079 | 3035 | 368 | 287 | 258 | 332 | 3192 | 1108 | 1100 | |
| UATYA160BFC3Y1 | 3118 | 3074 | 379 | 286 | 258 | 342 | 3155 | 1107 | 1098 | |
| UATYA180BFC3Y1 | 3236 | 3192 | 380 | 311 | 275 | 337 | 3234 | 1117 | 1101 | |
| UATYA190BFC3Y1 | 3315 | 3271 | 395 | 314 | 279 | 351 | 3195 | 1116 | 1065 | |

| Model | Rubber anti-vibration mounts | | | | Boxes to be ordered * |
|----------------|------------------------------|-----------|-----------|-----------|-------------------------------|
| | G1 | G2 | G3 | G4 | |
| UATYA140BFC3Y1 | UATYAAVM2 | UATYAAVM1 | UATYAAVM1 | UATYAAVM1 | 4 x UATYAAVM1 + 1 x UATYAAVM2 |
| UATYA150BFC3Y1 | UATYAAVM2 | UATYAAVM1 | UATYAAVM1 | UATYAAVM1 | 4 x UATYAAVM1 + 1 x UATYAAVM2 |
| UATYA160BFC3Y1 | UATYAAVM2 | UATYAAVM1 | UATYAAVM1 | UATYAAVM1 | 4 x UATYAAVM1 + 1 x UATYAAVM2 |
| UATYA180BFC3Y1 | UATYAAVM2 | UATYAAVM1 | UATYAAVM1 | UATYAAVM1 | 4 x UATYAAVM1 + 1 x UATYAAVM2 |
| UATYA190BFC3Y1 | UATYAAVM2 | UATYAAVM1 | UATYAAVM1 | UATYAAVM2 | 4 x UATYAAVM1 + 1 x UATYAAVM2 |

* Each box contains 2 mounts