

UATYA60-70BFC3Y1

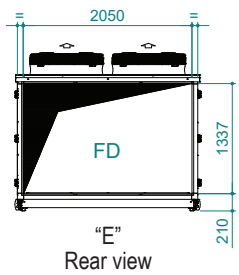

Air direction			
Air direction	Discharge	Intake	External
Left	LD	LI	LE
Right	RD	RI	RE
Top	TD	TI	/
Bottom	BD	BI	/
Front	FD	RI	/

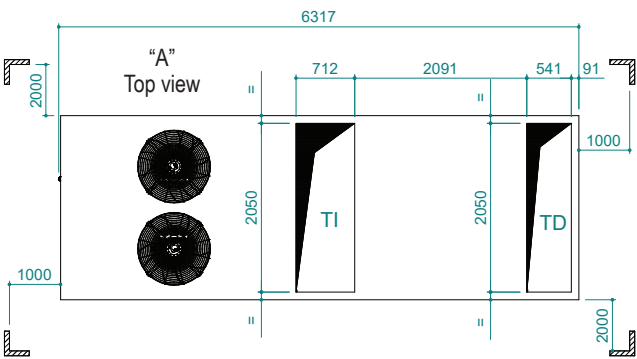
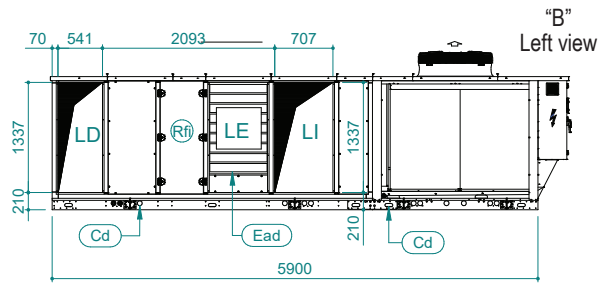
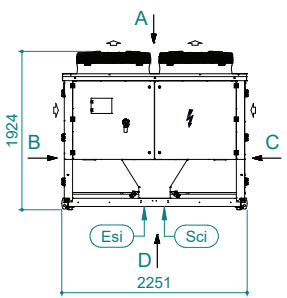
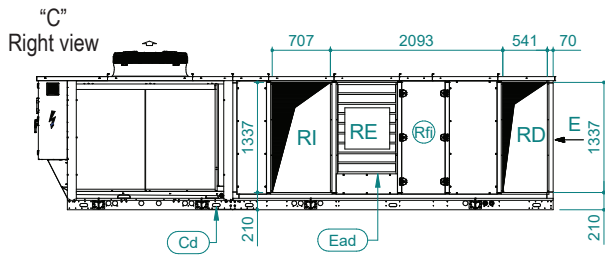
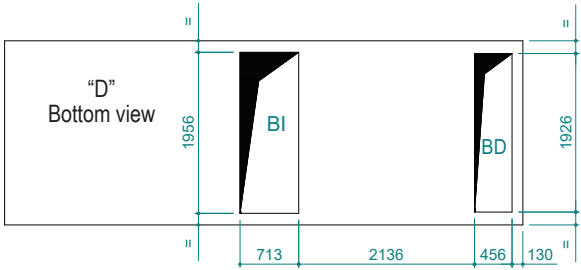

Sci	Signal cables inlet
Cd	Condensate drain 1" male

Ead	External air damper
Rfi	Remove for inspection

Esi	Electrical supply inlet
	Clearances

UATYA60-70BFC3Y1

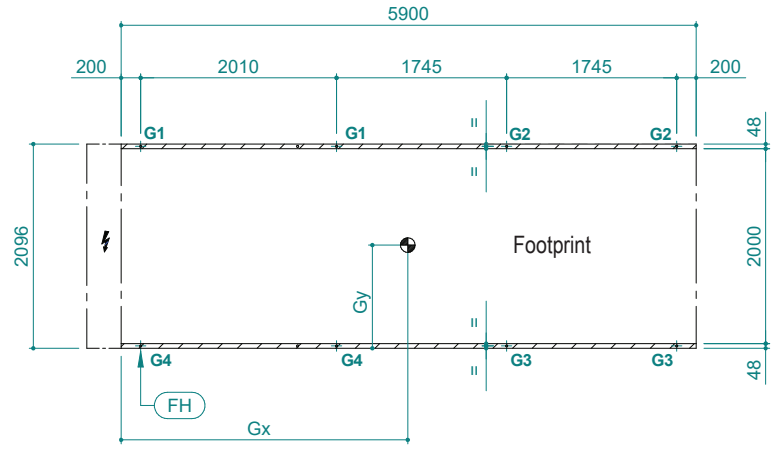
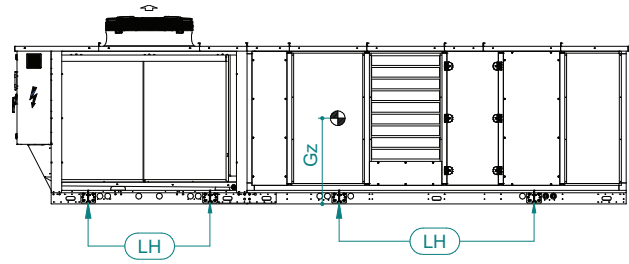

Fh	Fixing holes	Ø22	LH	Lifting point	G..	Vibration damper foot holds
----	--------------	-----	----	---------------	-----	-----------------------------

Model	Weight (kg)						(mm)		
	Shipping	Operating	G1	G2	G3	G4	Gx	Gy	Gz
UATYA60BFC3Y1	2035	1996	358	178	153	309	2739	1137	838
UATYA70BFC3Y1	2133	2094	399	185	147	316	2661	1185	841

Model	Rubber anti-vibration mounts				Boxes to be ordered *
	G1	G2	G3	G4	
UATYA60BFC3Y1	UATYAADM2	UATYAADM1	UATYAADM1	UATYAADM1	3 x UATYAADM1 + 1 x UATYAADM2
UATYA70BFC3Y1	UATYAADM2	UATYAADM1	UATYAADM1	UATYAADM1	3 x UATYAADM1 + 1 x UATYAADM2

* Each box contains 2 mounts