

2AMXM40M

Uscita di scarico
 Tubo flessibile di collegamento (diametro interno: 15.9mm)

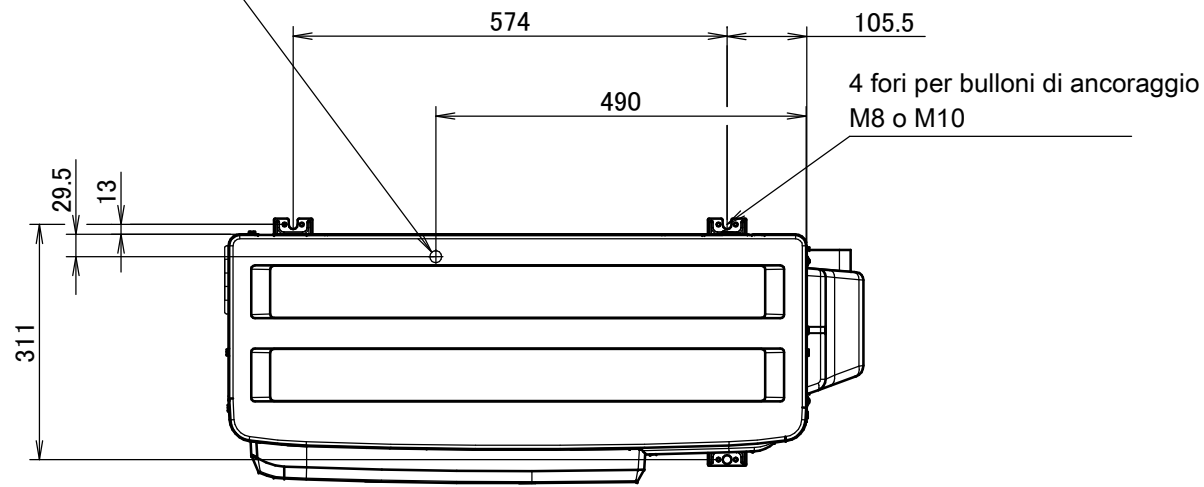

Spazio minimo per passaggio aria

Altezza a parete sul lato di uscita aria < 1200 mm

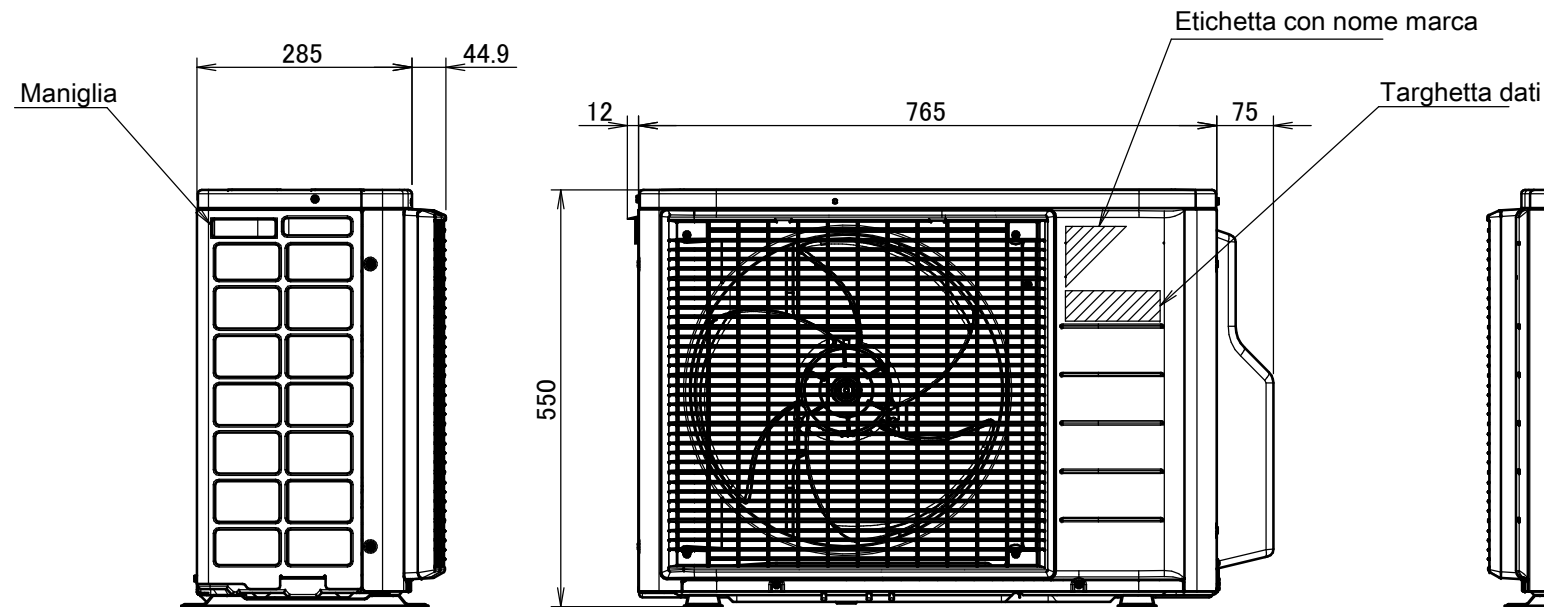
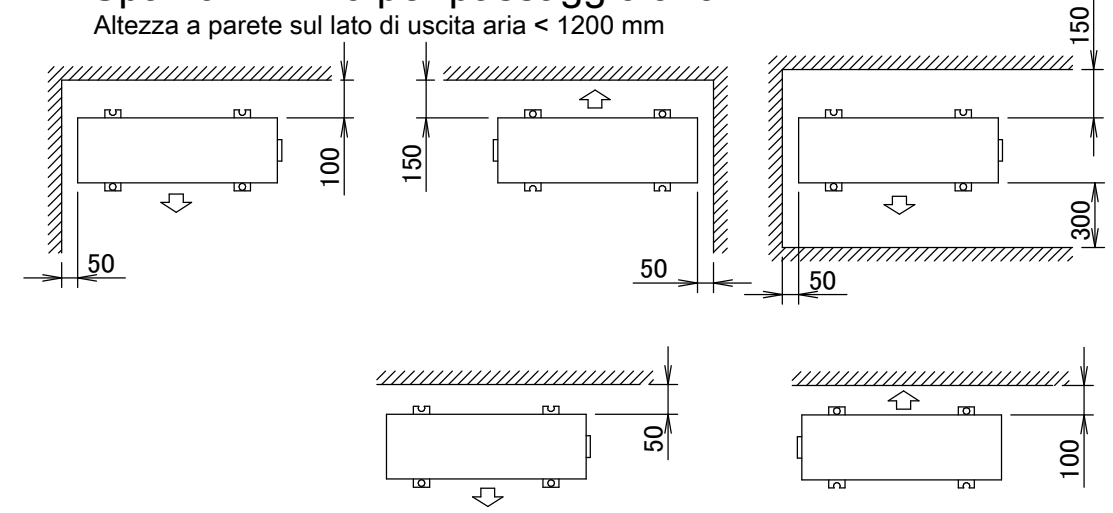

Morsettiera a striscia con terminale di terra

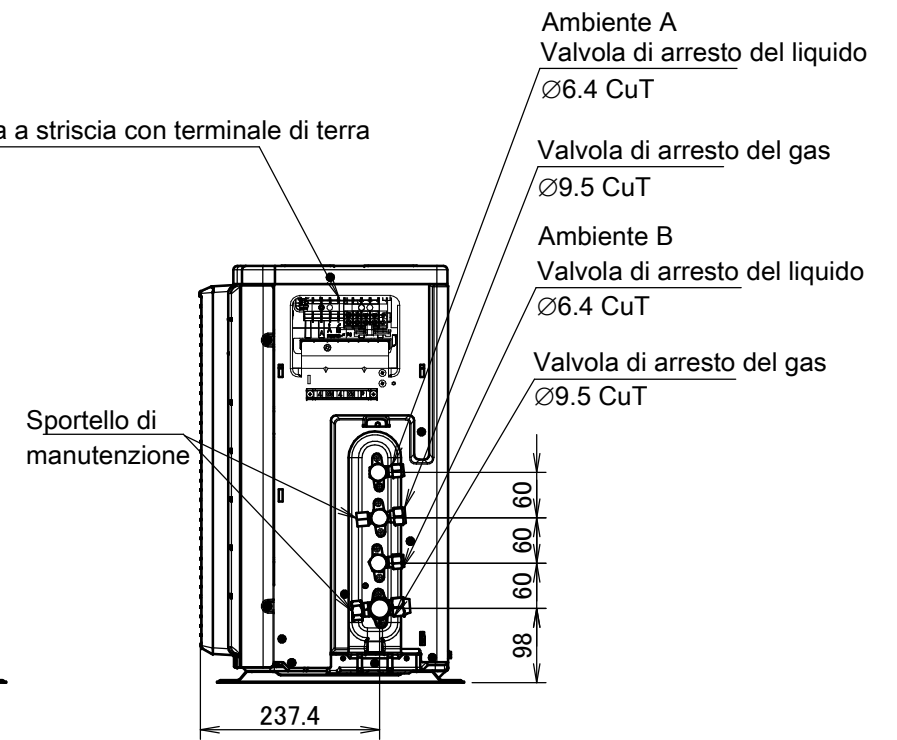
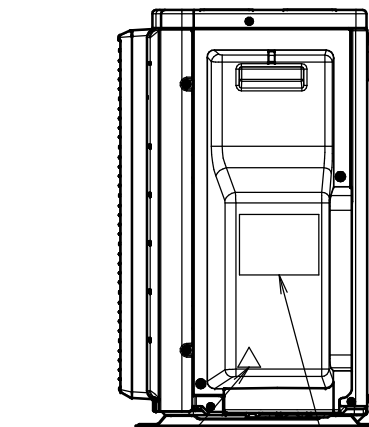

In caso di rimozione della copertura della valvola di arresto.

Termistore temperatura aria esterna

