

4MXS80E

unit (mm)

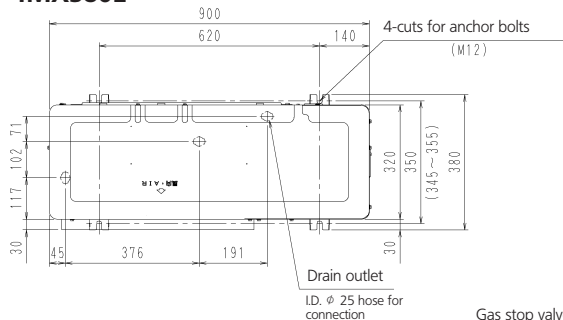

Minimum space for air passage

Wall height on air outlet side = less than 1200

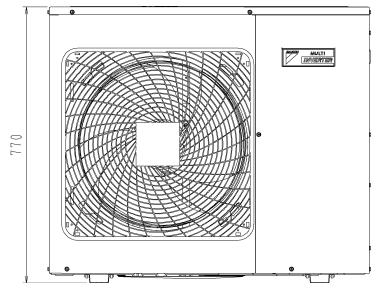
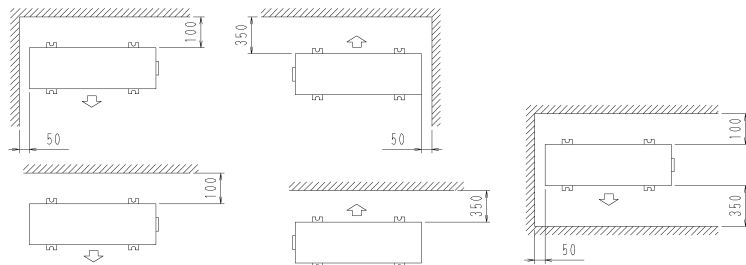

Name plate

Gas stop valve

5-Terminal strip with earth terminal

Liquid stop valve

Outdoor air thermistor

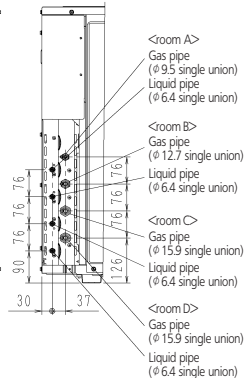
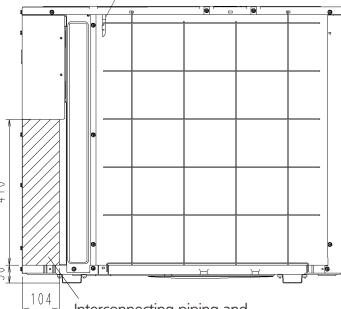
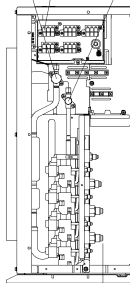
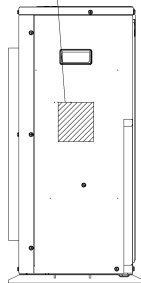

| | A |
|-------------|-----|
| ϕ 6.4 | 108 |
| ϕ 9.5 | 91 |
| ϕ 12.7 | 83 |
| ϕ 15.9 | 78 |