

Regolazione della direzione del flusso d'aria

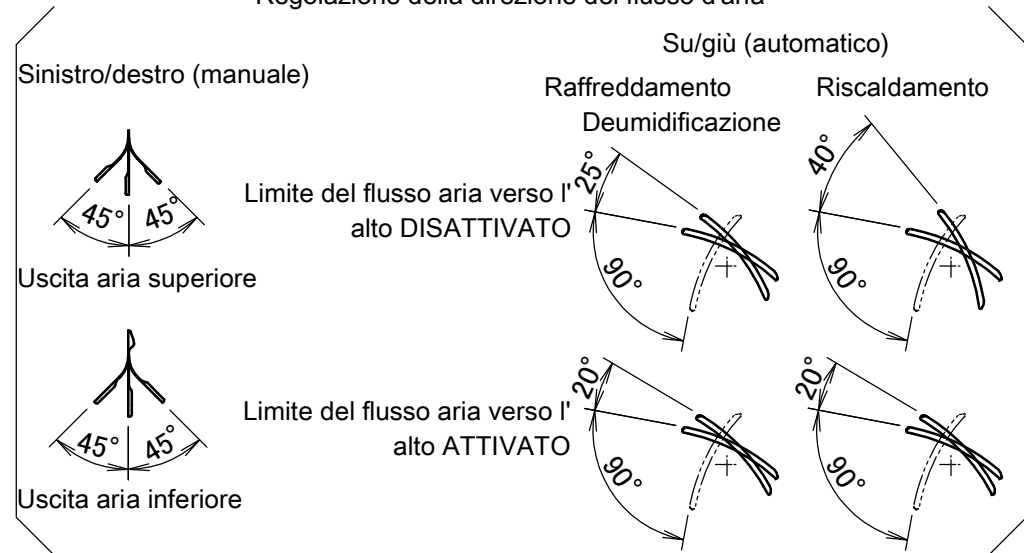

Note

Il segno → indica la direzione delle tubazioni.

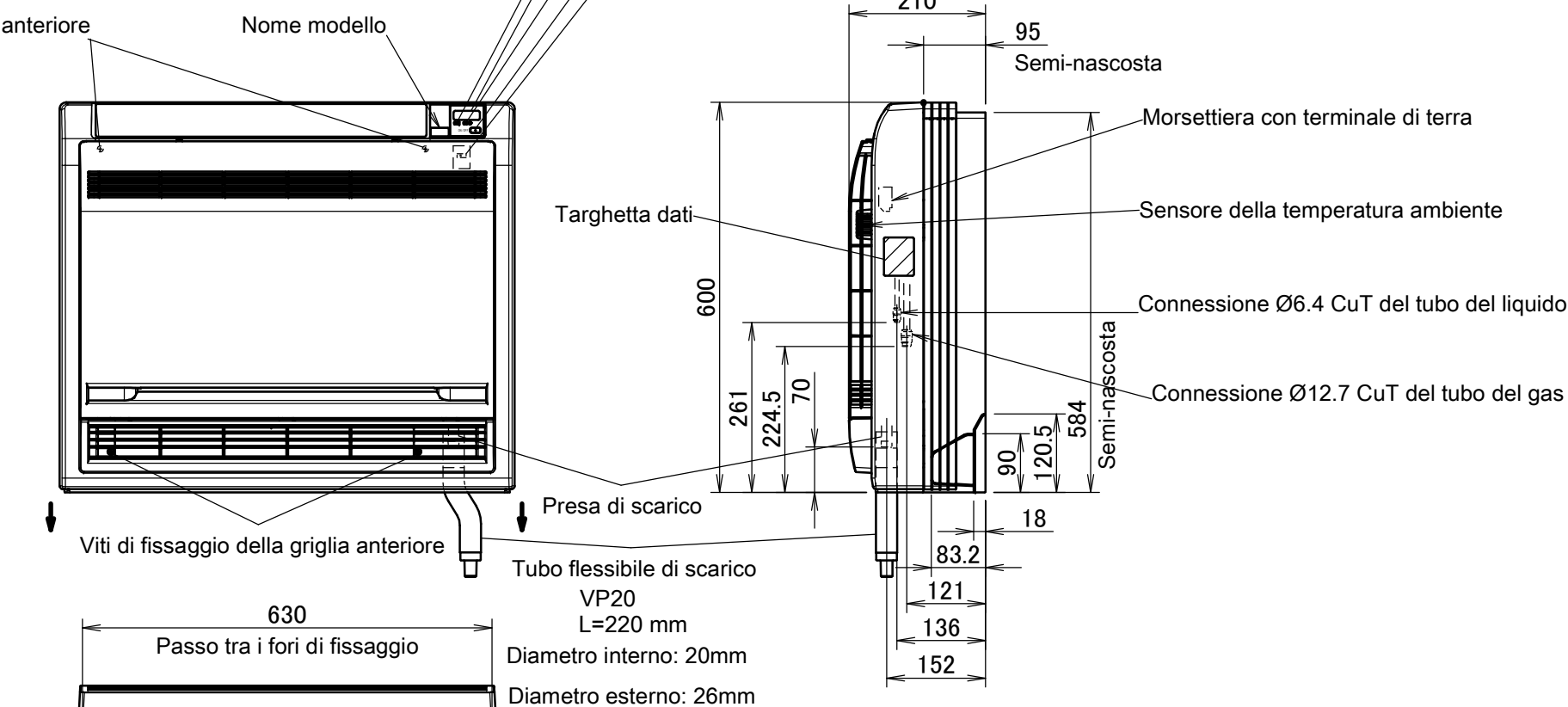
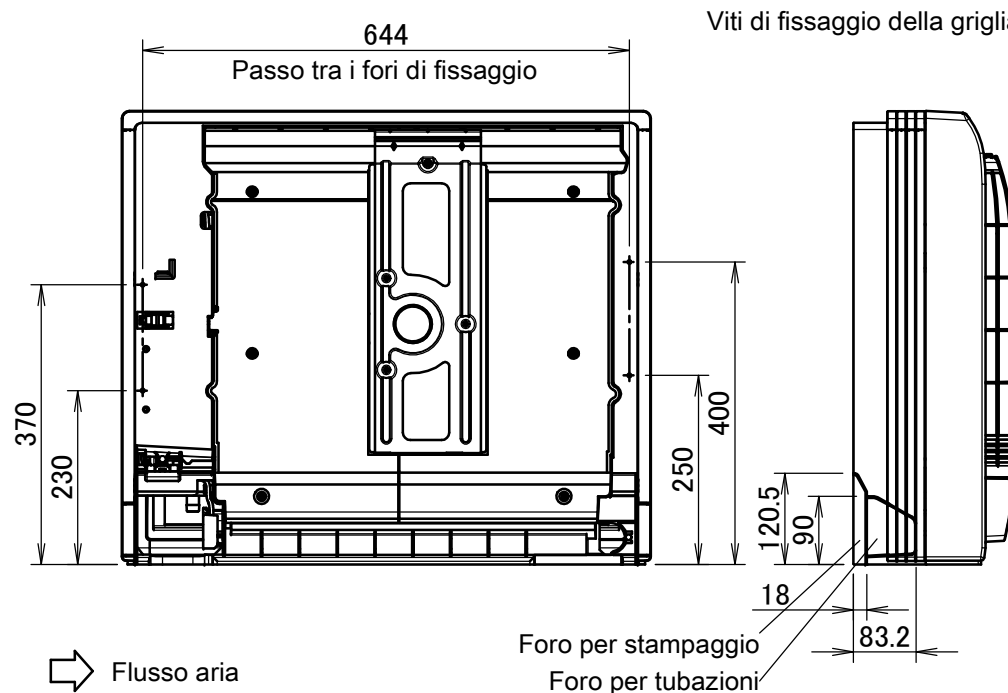
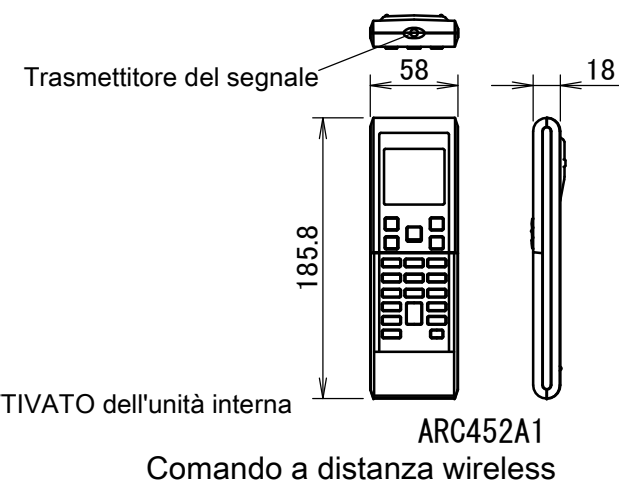

→ Flusso aria
 ⇄ Spazio necessario

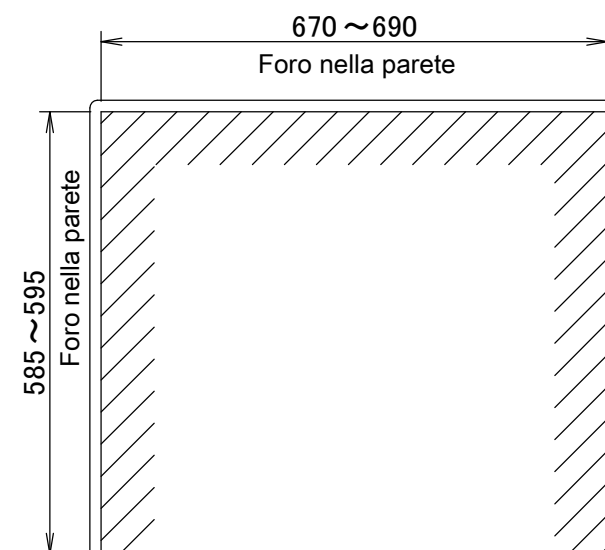
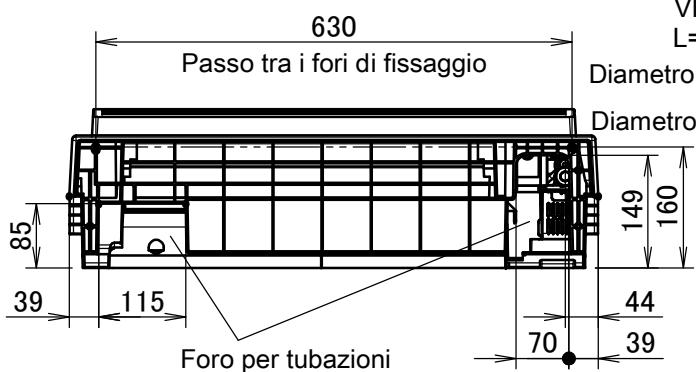
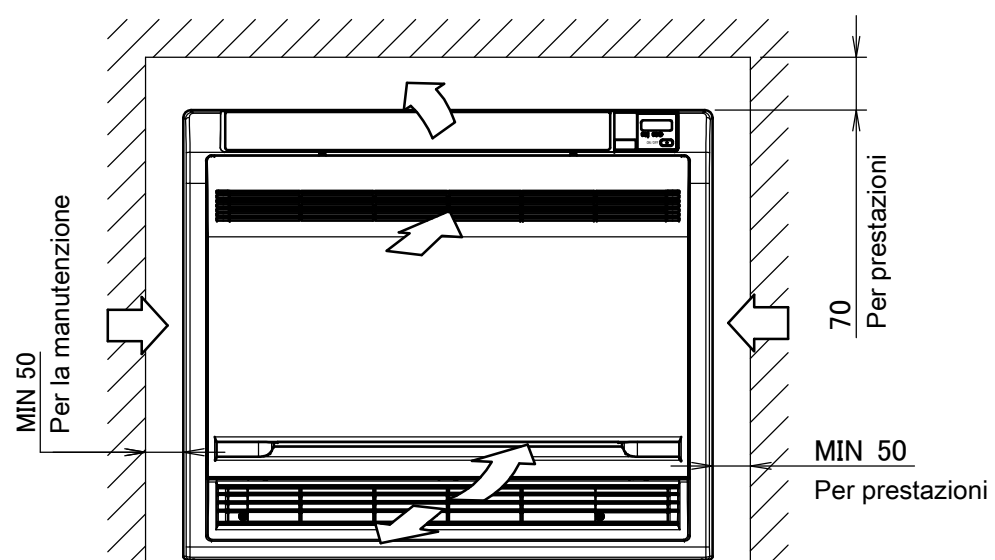

Foro nella parete per installazione semi-nascosta