

Notes

1. Location of nameplate
The unit nameplate is located on the control box cover.
The decoration panel nameplate is located on the piping-side panel frame, under the corner cover.
2. When installing optional accessories, refer to their respective documentation.
3. Make sure the distance between the ceiling and the cassette does not exceed 35-mm
The maximum ceiling opening is 910 mm.
4. When the conditions in the ceiling exceed 30°C ambient temperature and 80% relative humidity, or when fresh air is inducted into the ceiling, additional insulation is required (polyethylene foam, thickness ≥10 mm).
5. When installing a sensor kit, there will be a sensor on this location. For details, see the drawing of the sensor kit.
6. When installing a wireless controller, there will be a receiver on this location. For details, see the drawing of the wireless controller.

AA	AB	Model
204	140	FCAG35/50/60/71BVEB
246	180	FCAG100/125/140BVEB
288	180	FCAGH71/100/125/140HVEB
204	140	FXFQ20/25/32/40/50/63BVEB
246	180	FXFQ80/100BVEB
288	180	FXFQ125BVEB
204	140	FXFA20/25/32/40/50/63AZV
246	180	FXFA80/100AZVBE
288	180	FXFA125AZVBE

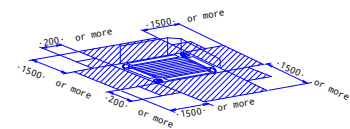
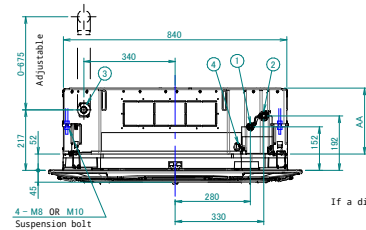
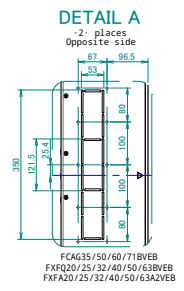
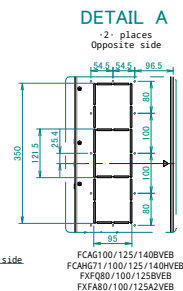
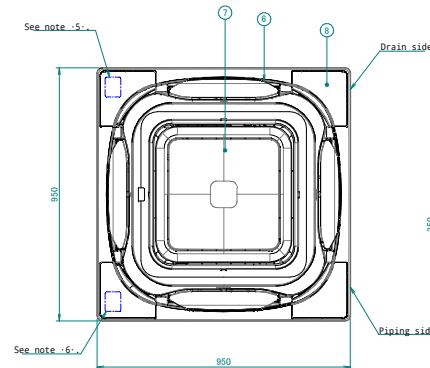
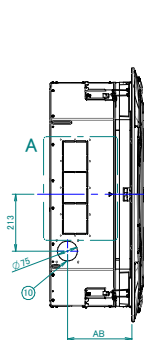
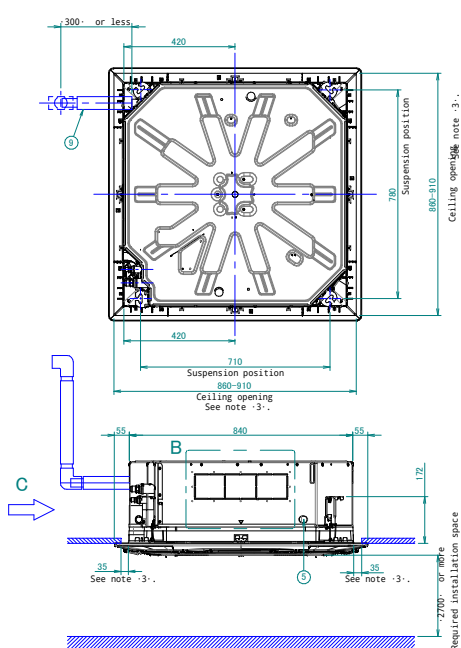

Required installation space

If a discharge outlet is closed up with the "sealing member" option kit, then the required installation space on that (closed up) side is 500-mm instead of 1500 mm.

ARROW VIEW C

Respect the distances shown on the figure.

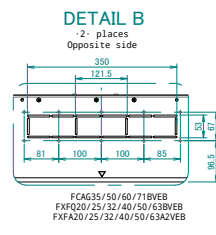
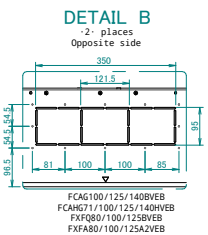
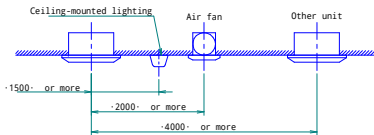

Item Name

- ① Liquid pipe connection port
- ② Gas pipe connection port
- ③ Drain pipe connection
- ④ Power supply wiring intake
- ⑤ Transmission wiring intake hole
- ⑥ Air discharge outlet
- ⑦ Flat grille assembly
- ⑧ Corner decoration cover
- ⑨ Drain hose
- ⑩ Knockout hole.