

# FXFA-A

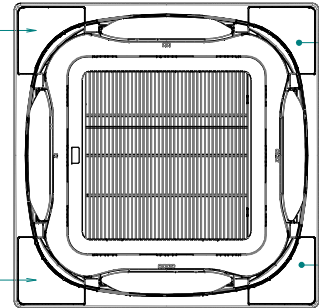

Minimal installation height		Model name
AA	AB	
277	319	FCAG35/50/60/71BVEB
		FXFQ20/25/32/40/50/63BVEB
		FXFA20/25/32/40/50/63A2VEB
319	361	FCAG100/125/140BVEB
		FXFQ80/100BVEB
		FXFA80/100A2VEB
361	403	FXFN50/71A2VEB
		FCAHG71/100/125/140HVEB
		FXFQ125BVEB
		FXFA125A2VEB
		FXFN112A2VEB

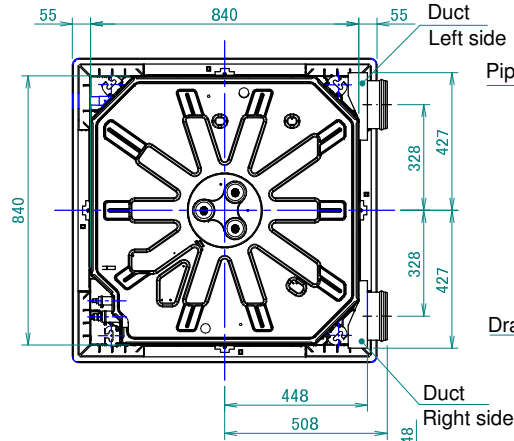
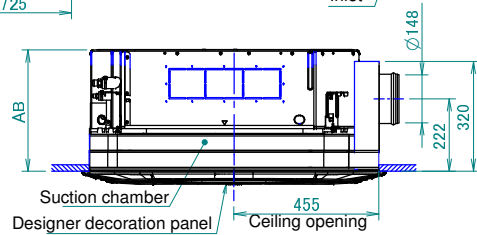
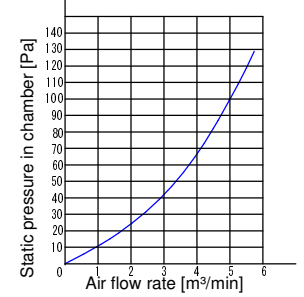
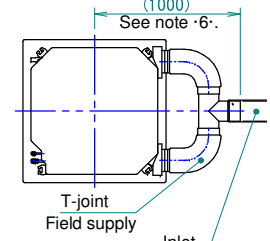
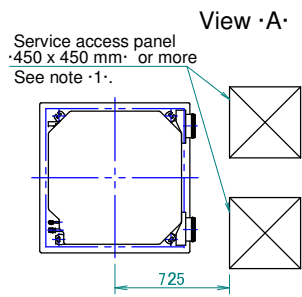
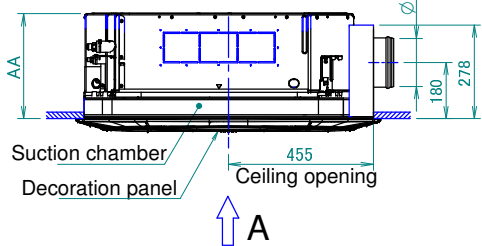

## Notes

- When installing a fresh air intake kit, provide a service access panel.
- Field construction
- This corner discharge outlet needs to be closed.
- When installing a duct fan, use a wiring adapter to link the duct fan to the fan of the indoor unit.
- The intake air flow rate is recommended to be  $\leq 20\%$  of the air flow rate at high fan speed. If the intake air flow rate is too large, the operating sound may increase, and the detection of the indoor unit suction temperature may be affected.
- This indicates the distance between the T-joint inlet and the indoor unit inlet when the T-tube is connected.