

# FXFA-A

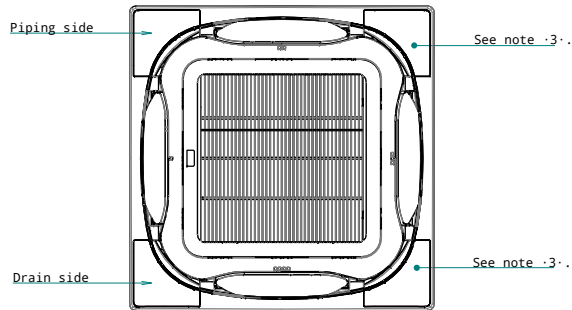

View A

Service access panel  
450 x 450 mm or more  
See note -1-

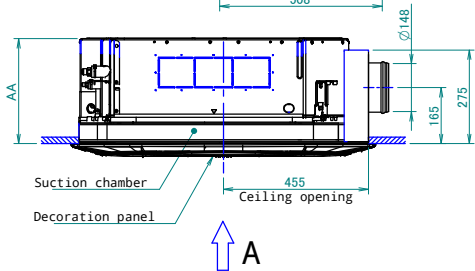
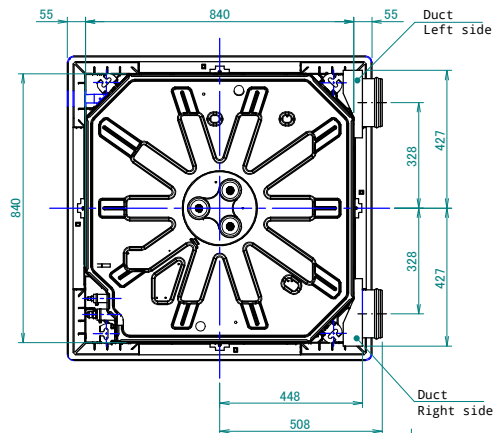
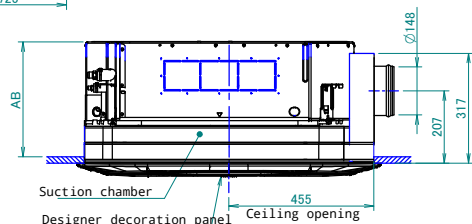
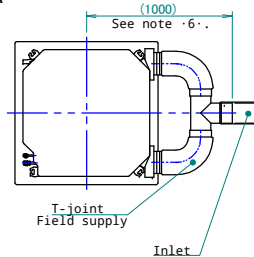
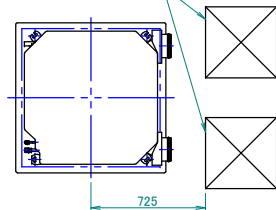

AA	AB	Model name
264	306	FCAG35/50/60/71BVEB
		FXFQ20/25/32/40/50/63BVEB
		FXFA20/25/32/40/50/63A2VEB
306	348	FCAG100/125/140BVEB
		FXFQ80/100BVEB
348	390	FXFA80/100A2VEB
		FCAG71/100/125/140HVEB
		FXFQ125BVEB
		FXFA125A2VEB

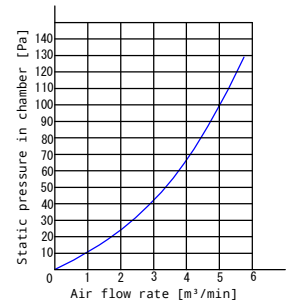

## Notes

1. When installing a fresh air intake kit, provide a service access panel.
2. Field construction
3. This corner discharge outlet needs to be closed.
4. When installing a duct fan, use a wiring adapter to link the duct fan to the fan of the indoor unit.
5. The intake air flow rate is recommended to be  $\leq 20\%$  of the air flow rate at high fan speed.  
If the intake air flow rate is too large, the operating sound may increase, and the detection of the indoor unit suction temperature may be affected.
6. This indicates the distance between the T-joint inlet and the indoor unit inlet when the T-tube is connected.