

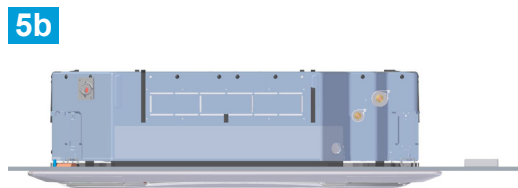

# BRP069C51 + FXZA15~50A2VEB

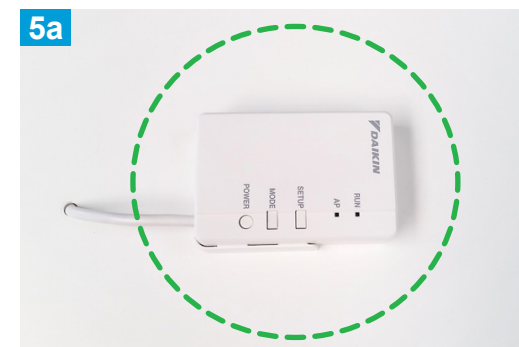

BRP069C51

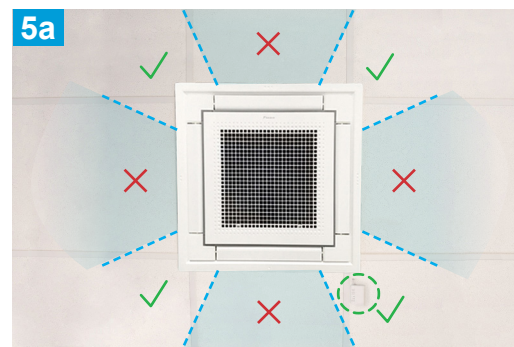
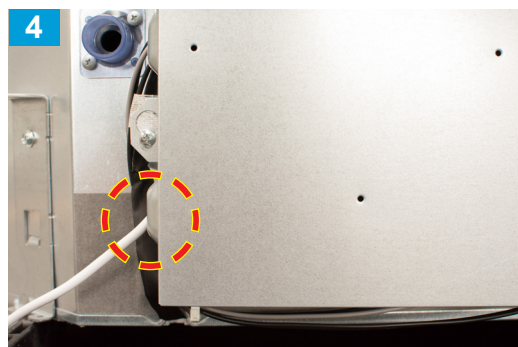
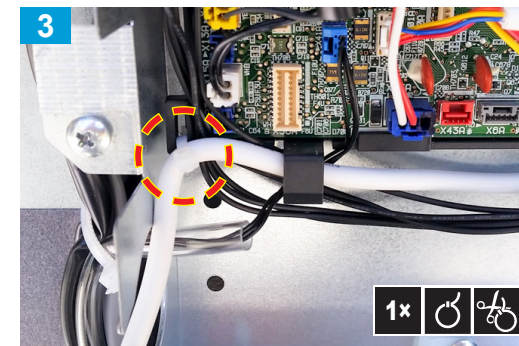
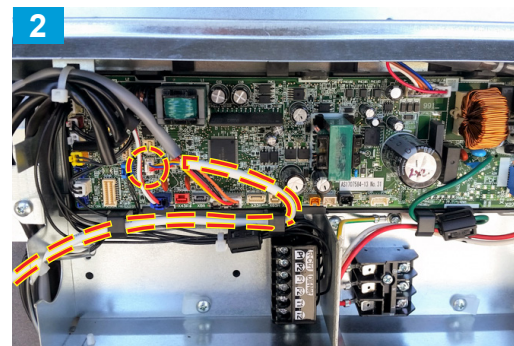
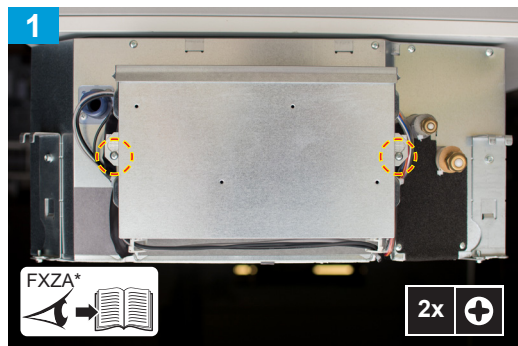
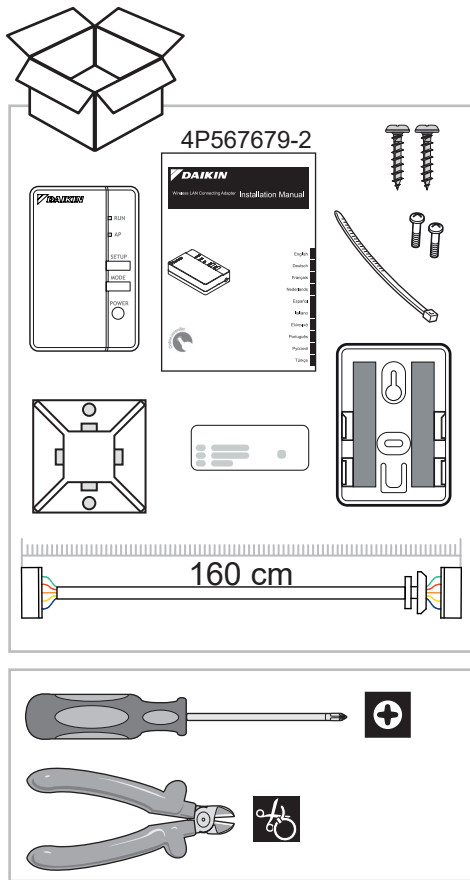